

Báscula inteligente para ganado

 **PATENT
PENDING**

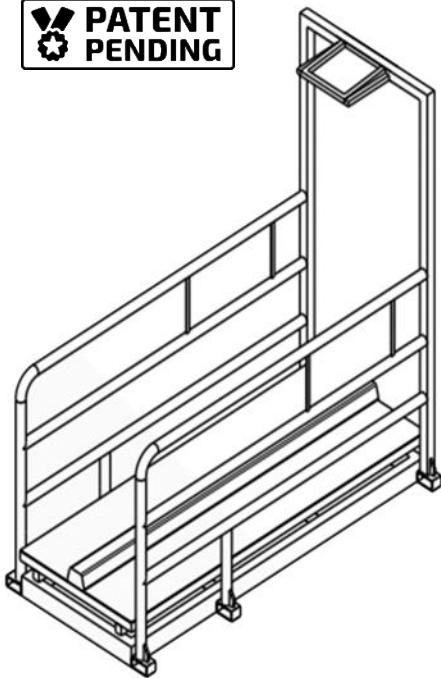

Datos técnicos

Dimensiones estándar

↙ Largo: 2m
Alto: 2m
Ancho: 0.9m
A medida

Durabilidad

 Robusto y seguro
Resistente a la corrosión
Células de acero inoxidable

Alimentación

 Monofásica 220v
AC | DC

Sistema operativo

 iOS & Android
PC web/app

Conectividad

 GSM Multioperador
WiFi*









Análisis de datos

 Análisis de datos continuo
Adaptación con terceras
plataformas





Crotales

 Passive UHF RFID tag

Funcionalidades

-  **Control de crecimiento**
-  **Lotes más equitativos**
-  **Detección de animales no rentables**
-  **Control exhaustivo**
-  **Mejora de rentabilidad**
-  **Detección de animalías**
-  **Notificaciones automáticas**
-  **Fácil manejo**

Notificaciones

-  **Crecimiento anómalo**
-  **Crecimiento no rentable**
-  **Peso objetivo**
-  **Ingesta anómala**

Consulta más información en:

www.digitanimal.com
info@digitanimal.com
+34 914 126 657